

Data sheet | Item number: 280-524

Double-deck terminal block; Through/through terminal block; with additional jumper position on lower level; for DIN-rail 35 x 15 and 35 x 7.5; 2.5 mm²; CAGE CLAMP®

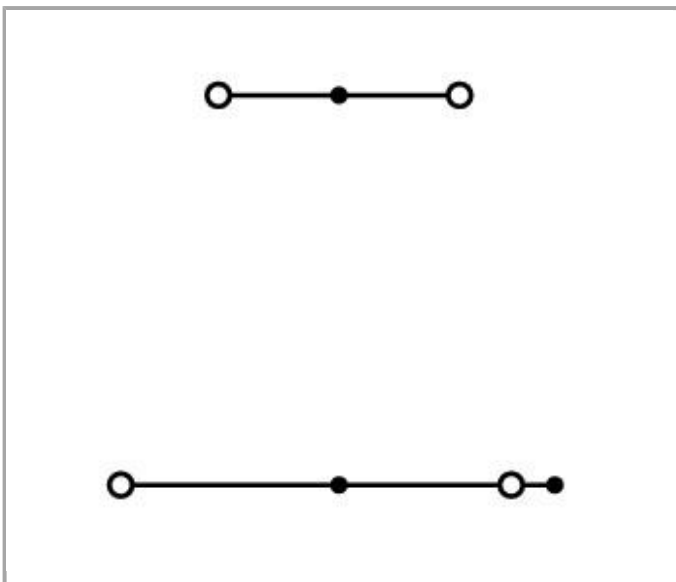

280-524

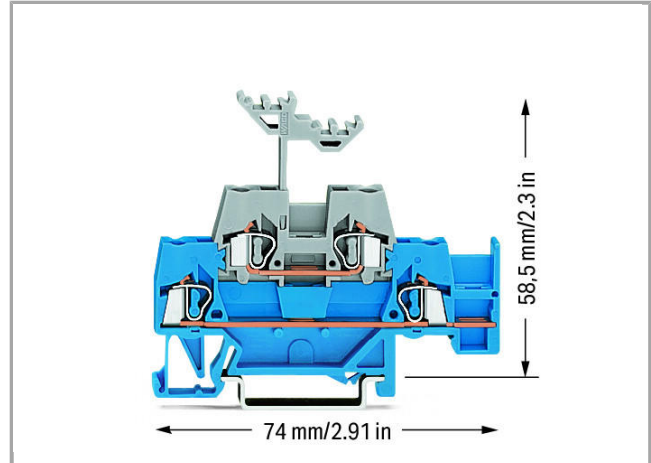
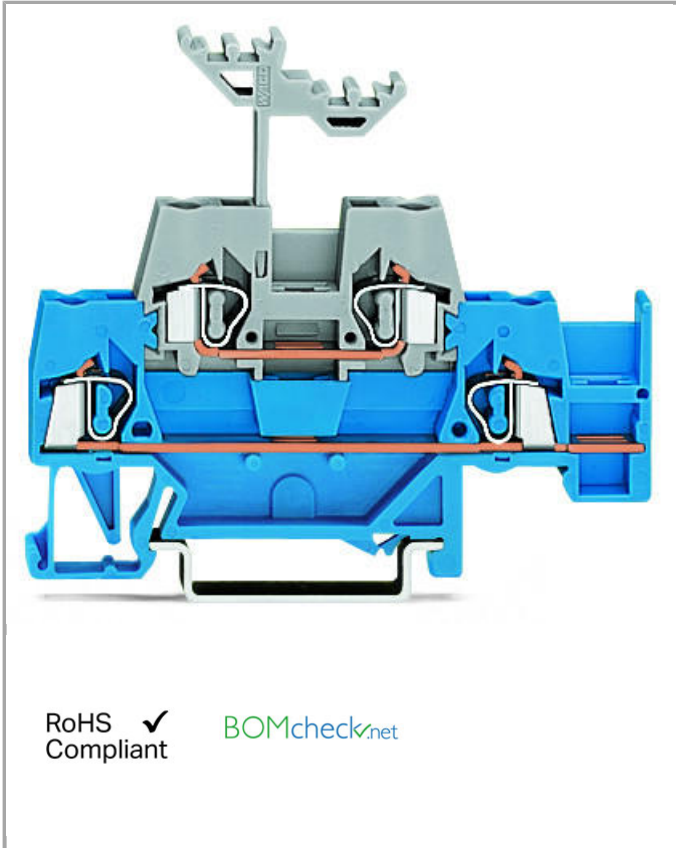

Item description

**Note:****Terminating Aluminum Conductors**

WAGO spring clamp terminal blocks are suitable for solid aluminum conductors up to 4 mm²/12 AWG if WAGO "Alu-Plus" Contact Paste is used for termination.

"Alu-Plus" Contact Paste Advantages:

- Automatically destroys the oxide film during clamping.
- Prevents fresh oxidation at the clamping point.
- Prevents electrolytic corrosion between aluminum and copper conductors (in the same terminal block).
- Provides long-term protection against corrosion.

Using terminal blocks with CAGE CLAMP® Spring Pressure Connection Technology, **aluminum conductors must first be cleaned with a blade** and then immediately be inserted into the clamping units filled with "Alu-Plus" Contact Paste.

It is also possible to apply WAGO "Alu-Plus" **additionally** on the whole surface of the aluminum conductor before termination.

Please note that the nominal currents must be adapted to the reduced conductivity of the aluminum conductors:

2.5 mm² (14 AWG) = 16 A

4 mm² (12 AWG) = 22 A

Data**Electrical data****Ratings per IEC/EN 60664-1**

Rated voltage (III / 3)	500 V
Rated impulse voltage (III / 3)	6 kV
Rated current	20 A

Connection data

Connection technology	CAGE CLAMP®
Actuation type	Operating tool
Connectable conductor materials	Copper Aluminum
Solid conductor	0.08 ... 2.5 mm ² / 28 ... 12 AWG
Fine-stranded conductor	0.08 ... 2.5 mm ² / 28 ... 12 AWG
Strip length	8 ... 9 mm / 0.31 ... 0.35 inch
Note (conductor cross-section)	12 AWG: THHN, THWN
Total number of connection points	4
Total number of potentials	2
Number of levels	2
Type of wiring	Front-entry wiring

Geometrical Data

Width	5 mm / 0.197 inch
Height from upper-edge of DIN-35 rail	58.5 mm / 2.303 inch
Depth	74 mm / 2.913 inch

Mechanical data

Design	horizontal
Type of mounting	DIN-35 rail
Marking level	Center marking

Material Data



Color	blue/gray
Insulating material	Polyamide 66 (PA 66)
Fire load	0.178 MJ
Weight	10.461 g

Commercial data

Product Group	1 (Rail Mounted Terminal Blocks)
Country of origin	CN
GTIN	4050821293637
Customs Tariff No.	85369010000



Approvals / Certificates

Country specific Approvals

Logo	Approval	Additional Approval Text	Certificate name
	CCA DEKRA Certification B.V.	EN 60947	2157201.01
	CSA DEKRA Certification B.V.	C22.2	1536071

Ship Approvals

Logo	Approval	Additional Approval Text	Certificate name
	ABS American Bureau of Shipping	EN 60947	14- HG1293677- PDA





	BV Bureau Veritas S.A.	EN 60947	07436/E0 BV
	DNV GL Det Norske Veritas, Germanischer Lloyd	-	TAE00001V2
	LR Lloyds Register	EN 60947	91/20112 (E9)















UL-Approvals

















Logo	Approval	Additional Approval Text	Certificate name
	UR Underwriters Laboratories Inc.	UL 1059	E45172



















Compatible products















Marking accessories

















	Item no.: 2009-115 WMB-Inline; for Smart Printer; on reel; stretchable 5 - 5.2 mm; plain; snap-on type	2009-115
	Item no.: 2009-115/000-002 WMB-Inline; for Smart Printer; on reel; stretchable 5 - 5.2 mm; plain; snap-on type	2009-115 /UUU-UUZ
	Item no.: 2009-115/000-006 WMB-Inline; for smartPRINTER; on reel; stretchable 5 - 5.2 mm; plain; snap-on type	2009-115 /UUU-UU6
	Item no.: 2009-115/000-007 WMB-Inline; for Smart Printer; on reel; stretchable 5 - 5.2 mm; plain; snap-on type	2009-115 /UUU-UU7















	Item no.: 2009-115/000-012 WMB-Inline; for smartPRINTER; on reel; stretchable 5 - 5.2 mm; plain; snap-on type	/000-012	2009-115
	Item no.: 2009-115/000-017 WMB-Inline; for Smart Printer; on reel; stretchable 5 - 5.2 mm; plain; snap-on type	/000-017	2009-115
	Item no.: 2009-115/000-023 WMB-Inline; for Smart Printer; on reel; stretchable 5 - 5.2 mm; plain; snap-on type	/000-023	2009-115
	Item no.: 2009-115/000-024 WMB-Inline; for smartPRINTER; on reel; stretchable 5 - 5.2 mm; plain; snap-on type	/000-024	2009-115
	Item no.: 793-501 WMB marking card; as card; not stretchable; plain; snap-on type		793-501
	Item no.: 793-501/000-002 WMB marking card; as card; not stretchable; plain; snap-on type	/000-002	793-501
	Item no.: 793-501/000-005 WMB marking card; as card; not stretchable; plain; snap-on type	/000-005	793-501
	Item no.: 793-501/000-006 WMB marking card; as card; not stretchable; plain; snap-on type	/000-006	793-501
	Item no.: 793-501/000-007 WMB marking card; as card; not stretchable; plain; snap-on type	/000-007	793-501
	Item no.: 793-501/000-012 WMB marking card; as card; not stretchable; plain; snap-on type	/000-012	793-501
	Item no.: 793-501/000-017 WMB marking card; as card; not stretchable; plain; snap-on type	/000-017	793-501
	Item no.: 793-501/000-023 WMB marking card; as card; not stretchable; plain; snap-on type	/000-023	793-501
	Item no.: 793-501/000-024 WMB marking card; as card; not stretchable; plain; snap-on type	/000-024	793-501
	Item no.: 793-5501 WMB marking card; as card; for terminal block width 5 - 17.5 mm; stretchable 5 - 5.2 mm; plain; snap-on type		793-5501
	Item no.: 793-5501/000-002 WMB marking card; as card; for terminal block width 5 - 17.5 mm; stretchable 5 - 5.2 mm; plain; snap-on type	/000-002	793-5501















	Item no.: 793-5501/000-005 WMB marking card; as card; stretchable 5 - 5.2 mm; plain; snap-on type	793-5501 /000-005
	Item no.: 793-5501/000-006 WMB marking card; as card; stretchable 5 - 5.2 mm; plain; snap-on type	793-5501 /000-006
	Item no.: 793-5501/000-007 WMB marking card; as card; stretchable 5 - 5.2 mm; plain; snap-on type	793-5501 /000-007
	Item no.: 793-5501/000-012 WMB marking card; as card; stretchable 5 - 5.2 mm; plain; snap-on type	793-5501 /000-012
	Item no.: 793-5501/000-017 WMB marking card; as card; stretchable 5 - 5.2 mm; plain; snap-on type	793-5501 /000-017
	Item no.: 793-5501/000-023 WMB marking card; as card; stretchable 5 - 5.2 mm; plain; snap-on type	793-5501 /000-023
	Item no.: 793-5501/000-024 WMB marking card; as card; stretchable 5 - 5.2 mm; plain; snap-on type	793-5501 /000-024
check		
	Item no.: 249-141 L-type test plug module; modular; with spring-loaded contact pin; Center module	249-141
End plate		
	Item no.: 280-342 End and intermediate plate; 2.5 mm thick	280-342
	Item no.: 280-343 End and intermediate plate; 2.5 mm thick	280-343
ferrule		
	Item no.: 216-101 Ferrule; Sleeve for 0.5 mm ² / AWG 22; uninsulated; electro-tin plated	216-101
	Item no.: 216-102 Ferrule; Sleeve for 0.75 mm ² / AWG 20; uninsulated; electro-tin plated	216-102
	Item no.: 216-103 Ferrule; Sleeve for 1 mm ² / AWG 18; uninsulated; electro-tin plated	216-103
	Item no.: 216-104 Ferrule; Sleeve for 1.5 mm ² / AWG 16; uninsulated; electro-tin plated	216-104
	Item no.: 216-201 Ferrule; Sleeve for 0.5 mm ² / 20 AWG; insulated; electro-tin plated	216-201
	Item no.: 216-202 Ferrule; Sleeve for 0.75 mm ² / 18 AWG; insulated; electro-tin plated	216-202















	Item no.: 216-203 Ferrule; Sleeve for 1 mm ² / AWG 18; insulated; electro-tin plated	216-203
	Item no.: 216-204 Ferrule; Sleeve for 1.5 mm ² / AWG 16; insulated; electro-tin plated	216-204
	Item no.: 216-301 Ferrule; Sleeve for 0.25 mm ² / AWG 24; insulated; electro-tin plated	216-301
	Item no.: 216-302 Ferrule; Sleeve for 0.34 mm ² / 22 AWG; insulated; electro-tin plated	216-302
Carrier rail		
	Item no.: 210-112 Steel carrier rail; 35 x 7.5 mm; 1 mm thick; 2 m long; slotted; according to EN 60715; "Hole width 25 mm	210-112
	Item no.: 210-113 Steel carrier rail; 35 x 7.5 mm; 1 mm thick; 2 m long; unslotted; according to EN 60715	210-113
	Item no.: 210-114 Steel carrier rail; 35 x 15 mm; 1.5 mm thick; 2 m long; unslotted; similar to EN 60715	210-114
	Item no.: 210-115 Steel carrier rail; 35 x 7.5 mm; 1 mm thick; 2 m long; slotted; according to EN 60715; "Hole width 18 mm	210-115
	Item no.: 210-118 Steel carrier rail; 35 x 15 mm; 2.3 mm thick; 2 m long; unslotted; according to EN 60715	210-118
	Item no.: 210-196 Aluminum carrier rail; 35 x 8.2 mm; 1.6 mm thick; 2 m long; unslotted; similar to EN 60715	210-196
	Item no.: 210-197 Steel carrier rail; 35 x 15 mm; 1.5 mm thick; 2 m long; slotted; similar to EN 60715	210-197
	Item no.: 210-198 Copper carrier rail; 35 x 15 mm; 2.3 mm thick; 2 m long; unslotted; according to EN 60715	210-198
	Item no.: 210-504 Steel carrier rail; 35 x 7.5 mm; 1 mm thick; 2 m long; slotted; galvanized; according to EN 60715	210-504
	Item no.: 210-505 Steel carrier rail; 35 x 7.5 mm; 1 mm thick; 2 m long; unslotted; galvanized; according to EN 60715	210-505
	Item no.: 210-506 Steel carrier rail; 35 x 15 mm; 1.5 mm thick; 2 m long; unslotted; galvanized; similar to EN 60715	210-506
	Item no.: 210-508 Steel carrier rail; 35 x 15 mm; 1.5 mm thick; 2 m long; slotted; galvanized; similar to EN 60715	210-508
Jumper		
	Item no.: 210-103 Wire commoning chain; insulated; 50 connections	210-103
	Item no.: 210-123 Wire commoning chain; insulated; 50 connections	210-123
	Item no.: 249-123 Push-in type wire jumper; insulated; wire length 180 mm; Conductor cross section 0.75 mm ²	249-123















	Item no.: 249-125 Push-in type wire jumper; insulated; wire length 60 mm; Conductor cross section 0.75 mm ²	249-125
	Item no.: 249-126 Push-in type wire jumper; insulated; wire length 110 mm; Conductor cross section 0.75 mm ²	249-126
	Item no.: 249-127 Push-in type wire jumper; insulated; wire length 250 mm; Conductor cross section 0.75 mm ²	249-127
	Item no.: 280-402 Adjacent jumper; insulated; IN = IN terminal block	280-402
	Item no.: 280-409 Alternate jumper; insulated; IN = IN terminal block	280-409
	Item no.: 280-482 Comb-style jumper bar; insulated; 2-way; IN = IN terminal block	280-482
	Item no.: 280-483 Comb-style jumper bar; insulated; 3-way; IN = IN terminal block	280-483
	Item no.: 280-484 Comb-style jumper bar; insulated; 4-way; IN = IN terminal block	280-484
	Item no.: 280-485 Comb-style jumper bar; insulated; 5-way; IN = IN terminal block	280-485
	Item no.: 280-490 Comb-style jumper bar; insulated; 10-way; IN = IN terminal block	280-490
	Item no.: 280-492 Alternate comb-style jumper bar; insulated; 2-way; IN = IN terminal block	280-492
	Item no.: 281-421 Vertical jumper; insulated; Nominal current 24 A	281-421
	Item no.: 709-110 Wire commoning chain; insulated; 4 connections; 3 x 110 mm	709-110
	Item no.: 709-111 Wire commoning chain; insulated; 3 connections; 2 x 120 mm	709-111
	Item no.: 709-112 Wire commoning chain; insulated; 3 connections; 2 x 170 mm	709-112
	Item no.: 780-452 Staggered jumper; insulated; from 1 to 2; Spacing: 5 mm; suitable for 2-conductor female plugs	780-452
	Item no.: 780-453 Staggered jumper; insulated; from 1 to 3; Spacing: 5 mm; suitable for 2-conductor female plugs	780-453
	Item no.: 780-454 Staggered jumper; insulated; from 1 to 4; Spacing: 5 mm; suitable for 2-conductor female plugs	780-454
	Item no.: 780-455 Staggered jumper; insulated; from 1 to 5; Spacing: 5 mm; suitable for 2-conductor female plugs	780-455
	Item no.: 780-456 Staggered jumper; insulated; from 1 to 6; Spacing: 5 mm; suitable for 2-conductor female plugs	780-456















	Item no.: 780-457 Staggered jumper; insulated; from 1 to 7; Spacing: 5 mm; suitable for 2-conductor female plugs	780-457
	Item no.: 780-458 Staggered jumper; insulated; from 1 to 8; Spacing: 5 mm; suitable for 2-conductor female plugs	780-458
assembling		
	Item no.: 209-106 Mounting carrier; for isolated mounting on DIN 35 rails	209-106
	Item no.: 709-154 Cover; Type 2; suitable for cover carrier, type 2; 1 m long	709-154
tools		
	Item no.: 210-657 Operating tool with partially insulated shaft; Blade (3.5 x 0.5) mm; short	210-657
	Item no.: 210-658 Operating tool with partially insulated shaft; Blade (3.5 x 0.5) mm; short; angled	210-658
	Item no.: 210-720 Operating tool with partially insulated shaft; Type 2, blade (3.5 x 0.5) mm	210-720
Insulation stop		
	Item no.: 280-470 Insulation stop; 0.08 - 0.2 mm ² "s" (0.14 mm ² "f-st"); 5 pieces/strip	280-470
	Item no.: 280-471 Insulation stop; 0.25 - 0.5 mm ² ; 5 pieces/strip	280-471
	Item no.: 280-472 Insulation stop; 0.75 - 1 mm ² ; 5 pieces/strip	280-472
Protective Warning Marker		
	Item no.: 280-415 Protective warning marker; with high-voltage symbol, black; for 5 terminal blocks	280-415
General accessories		
	Item no.: 231-162/003-000 Male connector for rail-mount terminal blocks; 1.2 x 1.2 mm pins; straight; Pin spacing 5 mm; 2-pole /UUU-UUU	231-162
	Item no.: 231-163/003-000 Male connector for rail-mount terminal blocks; 1.2 x 1.2 mm pins; straight; Pin spacing 5 mm; 3-pole /UUU-UUU	231-163
	Item no.: 231-164/003-000 Male connector for rail-mount terminal blocks; 1.2 x 1.2 mm pins; straight; Pin spacing 5 mm; 4-pole /UUU-UUU	231-164
	Item no.: 231-165/003-000 Male connector for rail-mount terminal blocks; 1.2 x 1.2 mm pins; straight; Pin spacing 5 mm; 5-pole /UUU-UUU	231-165
	Item no.: 231-166/003-000 Male connector for rail-mount terminal blocks; 1.2 x 1.2 mm pins; straight; Pin spacing 5 mm; 6-pole /UUU-UUU	231-166

	Item no.: 231-167/003-000 Male connector for rail-mount terminal blocks; 1.2 x 1.2 mm pins; straight; Pin spacing 5 mm; 7-pole /UU3-UUU	231-167
	Item no.: 231-168/003-000 Male connector for rail-mount terminal blocks; 1.2 x 1.2 mm pins; straight; Pin spacing 5 mm; 8-pole /UU3-UUU	231-168
	Item no.: 231-169/003-000 Male connector for rail-mount terminal blocks; 1.2 x 1.2 mm pins; straight; Pin spacing 5 mm; 9-pole /UU3-UUU	231-169
	Item no.: 231-170/003-000 Male connector for rail-mount terminal blocks; 1.2 x 1.2 mm pins; straight; Pin spacing 5 mm; 10-pole /UU3-UUU	231-170
	Item no.: 231-171/003-000 Male connector for rail-mount terminal blocks; 1.2 x 1.2 mm pins; straight; Pin spacing 5 mm; 11-pole /UU3-UUU	231-171
	Item no.: 231-172/003-000 Male connector for rail-mount terminal blocks; 1.2 x 1.2 mm pins; straight; Pin spacing 5 mm; 12-pole /UU3-UUU	231-172
	Item no.: 231-176/003-000 Male connector for rail-mount terminal blocks; 1.2 x 1.2 mm pins; straight; Pin spacing 5 mm; 16-pole /UU3-UUU	231-176
	Item no.: 231-180/003-000 Male connector for rail-mount terminal blocks; 1.2 x 1.2 mm pins; straight; Pin spacing 5 mm; 20-pole /UU3-UUU	231-180
	Item no.: 231-668 Lockout caps; for covering unused clamping units	231-668
	Item no.: 231-669 Lockout caps; for covering unused clamping units	231-669
	Item no.: 721-162/003-000 Male connector for rail-mount terminal blocks; 1.2 x 1.2 mm pins; straight; 100% protected against mismatching; Pin spacing 5 mm; 2-pole /UU3-UUU	721-162
	Item no.: 721-163/003-000 Male connector for rail-mount terminal blocks; 1.2 x 1.2 mm pins; straight; 100% protected against mismatching; Pin spacing 5 mm; 3-pole /UU3-UUU	721-163
	Item no.: 721-164/003-000 Male connector for rail-mount terminal blocks; 1.2 x 1.2 mm pins; straight; 100% protected against mismatching; Pin spacing 5 mm; 4-pole /UU3-UUU	721-164
	Item no.: 721-165/003-000 Male connector for rail-mount terminal blocks; 1.2 x 1.2 mm pins; straight; 100% protected against mismatching; Pin spacing 5 mm; 5-pole /UU3-UUU	721-165
	Item no.: 721-166/003-000 Male connector for rail-mount terminal blocks; 1.2 x 1.2 mm pins; straight; 100% protected against mismatching; Pin spacing 5 mm; 6-pole /UU3-UUU	721-166
	Item no.: 721-167/003-000	

	Male connector for rail-mount terminal blocks; 1.2 x 1.2 mm pins; straight; 100% protected against mismatching; Pin spacing 5 mm; 7-pole		721-167
		/003-000	
	Item no.: 721-168/003-000 Male connector for rail-mount terminal blocks; 1.2 x 1.2 mm pins; straight; 100% protected against mismatching; Pin spacing 5 mm; 8-pole		721-168
		/003-000	
	Item no.: 721-169/003-000 Male connector for rail-mount terminal blocks; 1.2 x 1.2 mm pins; straight; 100% protected against mismatching; Pin spacing 5 mm; 9-pole		721-169
		/003-000	
	Item no.: 721-170/003-000 Male connector for rail-mount terminal blocks; 1.2 x 1.2 mm pins; straight; 100% protected against mismatching; Pin spacing 5 mm; 10-pole		721-170
		/003-000	
	Item no.: 721-171/003-000 Male connector for rail-mount terminal blocks; 1.2 x 1.2 mm pins; straight; 100% protected against mismatching; Pin spacing 5 mm; 11-pole		721-171
		/003-000	
	Item no.: 721-172/003-000 Male connector for rail-mount terminal blocks; 1.2 x 1.2 mm pins; straight; 100% protected against mismatching; Pin spacing 5 mm; 12-pole		721-172
		/003-000	
	Item no.: 721-173/003-000 Male connector for rail-mount terminal blocks; 1.2 x 1.2 mm pins; straight; 100% protected against mismatching; Pin spacing 5 mm; 13-pole		721-173
		/003-000	
	Item no.: 721-174/003-000 Male connector for rail-mount terminal blocks; 1.2 x 1.2 mm pins; straight; 100% protected against mismatching; Pin spacing 5 mm; 14-pole		721-174
		/003-000	
	Item no.: 721-175/003-000 Male connector for rail-mount terminal blocks; 1.2 x 1.2 mm pins; straight; 100% protected against mismatching; Pin spacing 5 mm; 15-pole		721-175
		/003-000	
	Item no.: 721-176/003-000 Male connector for rail-mount terminal blocks; 1.2 x 1.2 mm pins; straight; 100% protected against mismatching; Pin spacing 5 mm; 16-pole		721-176
		/003-000	
	Item no.: 721-180/003-000 Male connector for rail-mount terminal blocks; 1.2 x 1.2 mm pins; straight; 100% protected against mismatching; Pin spacing 5 mm; 20-pole		721-180
		/003-000	
Female plug			
	Item no.: 232-132/005-000 Female connector for rail-mount terminal blocks; straight; Pin spacing 5 mm; 2-pole		232-132
		/005-000	
	Item no.: 232-132/005-000/039-000 Female connector for rail-mount terminal blocks; straight; Locking lever; Pin spacing 5 mm; 3-pole		232-132
		/005-000/039-000	
	Item no.: 232-133/005-000 Female connector for rail-mount terminal blocks; straight; Pin spacing 5 mm; 3-pole		232-133
		/005-000	

	Item no.: 232-133/005-000/039-000 Female connector for rail-mount terminal blocks; straight; Locking lever; Pin spacing 5 mm; 3-pole	232-133 /005-000/039-000
	Item no.: 232-134/005-000 Female connector for rail-mount terminal blocks; straight; Pin spacing 5 mm; 4-pole	232-134 /005-000
	Item no.: 232-134/005-000/039-000 Female connector for rail-mount terminal blocks; straight; Locking lever; Pin spacing 5 mm; 4-pole	232-134 /005-000/039-000
	Item no.: 232-135/005-000 Female connector for rail-mount terminal blocks; straight; Pin spacing 5 mm; 5-pole	232-135 /005-000
	Item no.: 232-135/005-000/039-000 Female connector for rail-mount terminal blocks; straight; Locking lever; Pin spacing 5 mm; 5-pole	232-135 /005-000/039-000
	Item no.: 232-136/005-000 Female connector for rail-mount terminal blocks; straight; Pin spacing 5 mm; 6-pole	232-136 /005-000
	Item no.: 232-136/005-000/039-000 Female connector for rail-mount terminal blocks; straight; Locking lever; Pin spacing 5 mm; 6-pole	232-136 /005-000/039-000
	Item no.: 232-137/005-000 Female connector for rail-mount terminal blocks; straight; Pin spacing 5 mm; 7-pole	232-137 /005-000
	Item no.: 232-137/005-000/039-000 Female connector for rail-mount terminal blocks; straight; Locking lever; Pin spacing 5 mm; 7-pole	232-137 /005-000/039-000
	Item no.: 232-138/005-000 Female connector for rail-mount terminal blocks; straight; Pin spacing 5 mm; 8-pole	232-138 /005-000
	Item no.: 232-138/005-000/039-000 Female connector for rail-mount terminal blocks; straight; Locking lever; Pin spacing 5 mm; 8-pole	232-138 /005-000/039-000
	Item no.: 232-139/005-000 Female connector for rail-mount terminal blocks; straight; Pin spacing 5 mm; 9-pole	232-139 /005-000
	Item no.: 232-139/005-000/039-000 Female connector for rail-mount terminal blocks; straight; Locking lever; Pin spacing 5 mm; 9-pole	232-139 /005-000/039-000
	Item no.: 232-140/005-000 Female connector for rail-mount terminal blocks; straight; Pin spacing 5 mm; 10-pole	232-140 /005-000
	Item no.: 232-140/005-000/039-000 Female connector for rail-mount terminal blocks; straight; Locking lever; Pin spacing 5 mm; 10-pole	232-140 /005-000/039-000

	Item no.: 232-142/005-000 Female connector for rail-mount terminal blocks; straight; Pin spacing 5 mm; 12-pole	232-142 /005-000
	Item no.: 232-142/005-000/039-000 Female connector for rail-mount terminal blocks; straight; Locking lever; Pin spacing 5 mm; 12-pole	232-142 /005-000/039-000
	Item no.: 232-146/005-000 Female connector for rail-mount terminal blocks; straight; Pin spacing 5 mm; 16-pole	232-146 /005-000
	Item no.: 232-146/005-000/039-000 Female connector for rail-mount terminal blocks; straight; Locking lever; Pin spacing 5 mm; 16-pole	232-146 /005-000/039-000
	Item no.: 232-147/005-000/039-000 Female connector for rail-mount terminal blocks; straight; Locking lever; Pin spacing 5 mm; 17-pole	232-147 /005-000/039-000
	Item no.: 232-150/005-000 Female connector for rail-mount terminal blocks; straight; Pin spacing 5 mm; 20-pole	232-150 /005-000
	Item no.: 232-150/005-000/039-000 Female connector for rail-mount terminal blocks; straight; Locking lever; Pin spacing 5 mm; 20-pole	232-150 /005-000/039-000
	Item no.: 232-232/005-000 Female connector for rail-mount terminal blocks; angled; Pin spacing 5 mm; 2-pole	232-232 /005-000
	Item no.: 232-232/005-000/039-000 Female connector for rail-mount terminal blocks; angled; Locking lever; Pin spacing 5 mm; 2-pole	232-232 /005-000/039-000
	Item no.: 232-233/005-000 Female connector for rail-mount terminal blocks; angled; Pin spacing 5 mm; 3-pole	232-233 /005-000
	Item no.: 232-233/005-000/039-000 Female connector for rail-mount terminal blocks; angled; Locking lever; Pin spacing 5 mm; 3-pole	232-233 /005-000/039-000
	Item no.: 232-234/005-000 Female connector for rail-mount terminal blocks; angled; Pin spacing 5 mm; 4-pole	232-234 /005-000
	Item no.: 232-234/005-000/039-000 Female connector for rail-mount terminal blocks; angled; Locking lever; Pin spacing 5 mm; 4-pole	232-234 /005-000/039-000
	Item no.: 232-235/005-000 Female connector for rail-mount terminal blocks; angled; Pin spacing 5 mm; 5-pole	232-235 /005-000

	Item no.: 232-235/005-000/039-000 Female connector for rail-mount terminal blocks; angled; Locking lever; Pin spacing 5 mm; 5-pole	232-235 /005-000/039-000
	Item no.: 232-236/005-000 Female connector for rail-mount terminal blocks; angled; Pin spacing 5 mm; 6-pole	232-236 /005-000
	Item no.: 232-236/005-000/039-000 Female connector for rail-mount terminal blocks; angled; Locking lever; Pin spacing 5 mm; 6-pole	232-236 /005-000/039-000
	Item no.: 232-237/005-000 Female connector for rail-mount terminal blocks; straight; Pin spacing 5 mm; 7-pole	232-237 /005-000
	Item no.: 232-238/005-000 Female connector for rail-mount terminal blocks; angled; Pin spacing 5 mm; 8-pole	232-238 /005-000
	Item no.: 232-239/005-000 Female connector for rail-mount terminal blocks; angled; Pin spacing 5 mm; 9-pole	232-239 /005-000
	Item no.: 232-240/005-000 Female connector for rail-mount terminal blocks; angled; Pin spacing 5 mm; 10-pole	232-240 /005-000
	Item no.: 232-240/005-000/039-000 Female connector for rail-mount terminal blocks; angled; Locking lever; Pin spacing 5 mm; 10-pole	232-240 /005-000/039-000
	Item no.: 232-242/005-000 Female connector for rail-mount terminal blocks; angled; Pin spacing 5 mm; 12-pole	232-242 /005-000
	Item no.: 232-242/005-000/039-000 Female connector for rail-mount terminal blocks; angled; Locking lever; Pin spacing 5 mm; 12-pole	232-242 /005-000/039-000
	Item no.: 232-246/005-000 Female connector for rail-mount terminal blocks; angled; Pin spacing 5 mm; 16-pole	232-246 /005-000
	Item no.: 232-246/005-000/039-000 Female connector for rail-mount terminal blocks; angled; Locking lever; Pin spacing 5 mm; 16-pole	232-246 /005-000/039-000
	Item no.: 232-250/005-000 Female connector for rail-mount terminal blocks; angled; Pin spacing 5 mm; 20-pole	232-250 /005-000
	Item no.: 232-250/005-000/039-000 Female connector for rail-mount terminal blocks; angled; Locking lever; Pin spacing 5 mm; 20-pole	232-250 /005-000/039-000
	Item no.: 232-732/005-000 Female connector for rail-mount terminal blocks; straight; Pin spacing 7.5 mm; 2-pole	232-732 /005-000

**Item no.: 232-733/005-000**

Female connector for rail-mount terminal blocks; straight; Pin spacing 7.5 mm; 3-pole

/005-000

232-733

**Item no.: 232-734/005-000**

Female connector for rail-mount terminal blocks; straight; Pin spacing 7.5 mm; 4-pole

/005-000

232-734

**Item no.: 232-734/005-000/039-000**

Female connector for rail-mount terminal blocks; straight; Pin spacing 7.5 mm; 4-pole

/005-000/039-000

232-734

**Item no.: 232-735/005-000**

Female connector for rail-mount terminal blocks; straight; Pin spacing 7.5 mm; 5-pole

/005-000

232-735

**Item no.: 232-735/005-000/039-000**

Female connector for rail-mount terminal blocks; straight; Pin spacing 7.5 mm; 5-pole

/005-000/039-000

232-735

**Item no.: 232-736/005-000**

Female connector for rail-mount terminal blocks; straight; Pin spacing 7.5 mm; 6-pole

/005-000

232-736

**Item no.: 232-736/005-000/039-000**

Female connector for rail-mount terminal blocks; straight; Pin spacing 7.5 mm; 6-pole

/005-000/039-000

232-736

**Item no.: 232-738/005-000**

Female connector for rail-mount terminal blocks; straight; Pin spacing 7.5 mm; 8-pole

/005-000

232-738

**Item no.: 232-740/005-000**

Female connector for rail-mount terminal blocks; straight; Pin spacing 7.5 mm; 10-pole

/005-000

232-740

**Item no.: 232-742/005-000**

Female connector for rail-mount terminal blocks; straight; Pin spacing 7.5 mm; 12-pole

/005-000

232-742

**Item no.: 232-832/005-000**

Female connector for rail-mount terminal blocks; angled; Pin spacing 7.5 mm; 2-pole

/005-000

232-832

**Item no.: 232-833/005-000**

Female connector for rail-mount terminal blocks; angled; Pin spacing 7.5 mm; 3-pole

/005-000

232-833

**Item no.: 232-834/005-000**

Female connector for rail-mount terminal blocks; angled; Pin spacing 7.5 mm; 4-pole

/005-000















232-834

**Item no.: 232-836/005-000**















Female connector for rail-mount terminal blocks; straight; Pin spacing 7.5 mm; 6-pole















/005-000















232-836

	Item no.: 232-836/005-000/039-000 Female connector for rail-mount terminal blocks; angled; Pin spacing 7.5 mm; 6-pole	232-836 /005-000/039-000
	Item no.: 232-840/005-000 Female connector for rail-mount terminal blocks; straight; Pin spacing 7.5 mm; 10-pole	232-840 /005-000
	Item no.: 232-842/005-000 Female connector for rail-mount terminal blocks; straight; Pin spacing 7.5 mm; 12-pole	232-842 /005-000
	Item no.: 722-132/005-000 Female connector for rail-mount terminal blocks; straight; 100% protected against mismatching; Pin spacing 5 mm; 2-pole	722-132 /005-000
	Item no.: 722-132/005-000/039-000 Female connector for rail-mount terminal blocks; straight; 100% protected against mismatching; Locking lever; Pin spacing 5 mm; 3-pole	722-132 /005-000/039-000
	Item no.: 722-133/005-000 Female connector for rail-mount terminal blocks; straight; 100% protected against mismatching; Pin spacing 5 mm; 3-pole	722-133 /005-000
	Item no.: 722-133/005-000/039-000 Female connector for rail-mount terminal blocks; straight; 100% protected against mismatching; Locking lever; Pin spacing 5 mm; 3-pole	722-133 /005-000/039-000
	Item no.: 722-134/005-000 Female connector for rail-mount terminal blocks; straight; 100% protected against mismatching; Pin spacing 5 mm; 4-pole	722-134 /005-000
	Item no.: 722-134/005-000/039-000 Female connector for rail-mount terminal blocks; straight; 100% protected against mismatching; Locking lever; Pin spacing 5 mm; 4-pole	722-134 /005-000/039-000
	Item no.: 722-135/005-000 Female connector for rail-mount terminal blocks; straight; 100% protected against mismatching; Pin spacing 5 mm; 5-pole	722-135 /005-000
	Item no.: 722-135/005-000/039-000 Female connector for rail-mount terminal blocks; straight; 100% protected against mismatching; Locking lever; Pin spacing 5 mm; 5-pole	722-135 /005-000/039-000
	Item no.: 722-136/005-000 Female connector for rail-mount terminal blocks; straight; 100% protected against mismatching; Pin spacing 5 mm; 6-pole	722-136 /005-000
	Item no.: 722-136/005-000/039-000 Female connector for rail-mount terminal blocks; straight; 100% protected against mismatching; Locking lever; Pin spacing 5 mm; 6-pole	722-136 /005-000/039-000
	Item no.: 722-137/005-000 Female connector for rail-mount terminal blocks; straight; 100% protected against mismatching; Pin spacing 5 mm; 7-pole	722-137 /005-000
	Item no.: 722-137/005-000/039-000 Female connector for rail-mount terminal blocks; straight; 100% protected against mismatching;	722-137 /005-000/039-000

Locking lever; Pin spacing 5 mm; 7-pole

	Item no.: 722-138/005-000 Female connector for rail-mount terminal blocks; straight; 100% protected against mismatching; Pin spacing 5 mm; 8-pole	722-138 /005-000
	Item no.: 722-138/005-000/039-000 Female connector for rail-mount terminal blocks; straight; 100% protected against mismatching; Locking lever; Pin spacing 5 mm; 8-pole	722-138 /005-000/039-000
	Item no.: 722-139/005-000 Female connector for rail-mount terminal blocks; straight; 100% protected against mismatching; Pin spacing 5 mm; 9-pole	722-139 /005-000
	Item no.: 722-139/005-000/039-000 Female connector for rail-mount terminal blocks; straight; 100% protected against mismatching; Locking lever; Pin spacing 5 mm; 9-pole	722-139 /005-000/039-000
	Item no.: 722-140/005-000 Female connector for rail-mount terminal blocks; straight; 100% protected against mismatching; Pin spacing 5 mm; 10-pole	722-140 /005-000
	Item no.: 722-140/005-000/039-000 Female connector for rail-mount terminal blocks; straight; 100% protected against mismatching; Locking lever; Pin spacing 5 mm; 10-pole	722-140 /005-000/039-000
	Item no.: 722-141/005-000 Female connector for rail-mount terminal blocks; straight; 100% protected against mismatching; Pin spacing 5 mm; 11-pole	722-141 /005-000
	Item no.: 722-142/005-000 Female connector for rail-mount terminal blocks; straight; 100% protected against mismatching; Pin spacing 5 mm; 12-pole	722-142 /005-000
	Item no.: 722-142/005-007/039-000 Female connector for rail-mount terminal blocks; straight; 100% protected against mismatching; Locking lever; Pin spacing 5 mm; 12-pole	722-142 /005-007/039-000
	Item no.: 722-143/005-000 Female connector for rail-mount terminal blocks; angled; 100% protected against mismatching; Pin spacing 5 mm; 13-pole	722-143 /005-000
	Item no.: 722-144/005-000 Female connector for rail-mount terminal blocks; straight; 100% protected against mismatching; Pin spacing 5 mm; 14-pole	722-144 /005-000
	Item no.: 722-144/005-000/039-000 Female connector for rail-mount terminal blocks; straight; 100% protected against mismatching; Locking lever; Pin spacing 5 mm; 14-pole	722-144 /005-000/039-000
	Item no.: 722-145/005-000 Female connector for rail-mount terminal blocks; straight; 100% protected against mismatching; Pin spacing 5 mm; 15-pole	722-145 /005-000
	Item no.: 722-146/005-000 Female connector for rail-mount terminal blocks; straight; 100% protected against mismatching; Pin spacing 5 mm; 16-pole	722-146 /005-000
	Item no.: 722-146/005-000/039-000	

	Female connector for rail-mount terminal blocks; straight; 100% protected against mismatching; Locking lever; Pin spacing 5 mm; 16-pole	722-146 /005-000/039-000
	Item no.: 722-150/005-000 Female connector for rail-mount terminal blocks; straight; 100% protected against mismatching; Pin spacing 5 mm; 20-pole	722-150 /005-000
	Item no.: 722-150/005-000/039-000 Female connector for rail-mount terminal blocks; straight; 100% protected against mismatching; Locking lever; Pin spacing 5 mm; 20-pole	722-150 /005-000/039-000
	Item no.: 722-232/005-000 Female connector for rail-mount terminal blocks; angled; 100% protected against mismatching; Pin spacing 5 mm; 3-pole	722-232 /005-000
	Item no.: 722-232/005-000/039-000 Female connector for rail-mount terminal blocks; straight; 100% protected against mismatching; Locking lever; Pin spacing 5 mm; 3-pole	722-232 /005-000/039-000
	Item no.: 722-233/005-000 Female connector for rail-mount terminal blocks; angled; 100% protected against mismatching; Pin spacing 5 mm; 3-pole	722-233 /005-000
	Item no.: 722-233/005-000/039-000 Female connector for rail-mount terminal blocks; angled; 100% protected against mismatching; Locking lever; Pin spacing 5 mm; 3-pole	722-233 /005-000/039-000
	Item no.: 722-234/005-000 Female connector for rail-mount terminal blocks; angled; 100% protected against mismatching; Pin spacing 5 mm; 4-pole	722-234 /005-000
	Item no.: 722-234/005-000/039-000 Female connector for rail-mount terminal blocks; straight; 100% protected against mismatching; Locking lever; Pin spacing 5 mm; 4-pole	722-234 /005-000/039-000
	Item no.: 722-235/005-000 Female connector for rail-mount terminal blocks; angled; 100% protected against mismatching; Pin spacing 5 mm; 5-pole	722-235 /005-000
	Item no.: 722-235/005-000/039-000 Female connector for rail-mount terminal blocks; angled; 100% protected against mismatching; Locking lever; Pin spacing 5 mm; 5-pole	722-235 /005-000/039-000
	Item no.: 722-236/005-000 Female connector for rail-mount terminal blocks; angled; 100% protected against mismatching; Pin spacing 5 mm; 6-pole	722-236 /005-000
	Item no.: 722-236/005-000/039-000 Female connector for rail-mount terminal blocks; angled; 100% protected against mismatching; Locking lever; Pin spacing 5 mm; 6-pole	722-236 /005-000/039-000
	Item no.: 722-237/005-000 Female connector for rail-mount terminal blocks; angled; 100% protected against mismatching; Pin spacing 5 mm; 7-pole	722-237 /005-000
	Item no.: 722-237/005-000/039-000 Female connector for rail-mount terminal blocks; angled; 100% protected against mismatching; Locking lever; Pin spacing 5 mm; 7-pole	722-237 /005-000/039-000

	Item no.: 722-238/005-000 Female connector for rail-mount terminal blocks; angled; 100% protected against mismatching; Pin spacing 5 mm; 8-pole	722-238 /005-000
	Item no.: 722-239/005-000 Female connector for rail-mount terminal blocks; angled; 100% protected against mismatching; Pin spacing 5 mm; 9-pole	722-239 /005-000
	Item no.: 722-239/005-000/039-000 Female connector for rail-mount terminal blocks; angled; 100% protected against mismatching; Locking lever; Pin spacing 5 mm; 9-pole	722-239 /005-000/039-000
	Item no.: 722-240/005-000 Female connector for rail-mount terminal blocks; angled; 100% protected against mismatching; Pin spacing 5 mm; 10-pole	722-240 /005-000
	Item no.: 722-240/005-000/039-000 Female connector for rail-mount terminal blocks; angled; 100% protected against mismatching; Locking lever; Pin spacing 5 mm; 10-pole	722-240 /005-000/039-000
	Item no.: 722-241/005-000 Female connector for rail-mount terminal blocks; straight; 100% protected against mismatching; Pin spacing 5 mm; 11-pole	722-241 /005-000
	Item no.: 722-242/005-000 Female connector for rail-mount terminal blocks; angled; 100% protected against mismatching; Pin spacing 5 mm; 12-pole	722-242 /005-000
	Item no.: 722-242/005-000/039-000 Female connector for rail-mount terminal blocks; angled; 100% protected against mismatching; Locking lever; Pin spacing 5 mm; 12-pole	722-242 /005-000/039-000
	Item no.: 722-243/005-000 Female connector for rail-mount terminal blocks; angled; 100% protected against mismatching; Pin spacing 5 mm; 13-pole	722-243 /005-000
	Item no.: 722-244/005-000 Female connector for rail-mount terminal blocks; angled; 100% protected against mismatching; Pin spacing 5 mm; 14-pole	722-244 /005-000
	Item no.: 722-244/005-000/039-000 Female connector for rail-mount terminal blocks; angled; 100% protected against mismatching; Locking lever; Pin spacing 5 mm; 14-pole	722-244 /005-000/039-000
	Item no.: 722-246/005-000 Female connector for rail-mount terminal blocks; angled; 100% protected against mismatching; Pin spacing 5 mm; 16-pole	722-246 /005-000
	Item no.: 722-246/005-000/039-000 Female connector for rail-mount terminal blocks; angled; 100% protected against mismatching; Locking lever; Pin spacing 5 mm; 16-pole	722-246 /005-000/039-000
	Item no.: 722-250/005-000 Female connector for rail-mount terminal blocks; angled; 100% protected against mismatching; Pin spacing 5 mm; 20-pole	722-250 /005-000



Downloads

Documentation

Bid Text

280-524	doc 25.1 kB	Download
---------	----------------	----------

CAD/CAE - Smart Data

CAD data

3D Download 280-524	URL	Download
---------------------	-----	----------

Subject to changes.
